



# **AUTOMATED OUTDOOR ANIMAL MONITORING**

## **TrackSnap Manual**

### **Sony DSC-P41**

**Model TS-DSC-P41-01**

**Document Author:** Paul Skelly  
**Version:** TS P41.2  
**Issue Date:** 01/01/06  
**Status:** Released  
**Document Location:** <http://www.tracksnap.com/>

## Introduction

Congratulations on the purchase of a new TrackSnap camera system. This manual provides detailed information for the setup and use of your system.

Please read this manual before using your TrackSnap camera. The information provided will give you good service from your system.

At the heart of any motion sensing camera is a controller board. All TrackSnap cameras use a PixController PIR (**Pryoelectric Infra-Red**) motion detection sensor. The PixController motion sensor electronics is a unique design. With this design you will get the minimum number of false triggers (blank photos), and the PIR electronics will shut down when the board battery gets low also minimising false photos. It can detect the target in any vector of travel (say up and down target movement), which is very important if you plan to mount your sensor in an elevated position.

Knowing your system is working in the field all the time is what you expect from our high quality products!

## TrackSnap Setup Tips

- Ensure the DSC-P41 camera is set up correctly, Camera Mode Selector is in the Still Image position and turned off as per page 11 of this manual. The TrackSnap controller will power the camera when required and will not function correctly without these correct settings..
- Utilise the Auto **Walk-Test Mode** to confirm settings after positioning the camera as suggested below. See top of page 4 for auto walk-test mode information.
- Position the camera correctly
  - Point the sensor away from the rising or setting sun. In general, North or South works well, but your local site conditions could dictate otherwise.
  - Keep the sensor aimed at an area that will not have intense, direct sunlight warming all or part of the detection area. Shadows of trees or clouds moving across a sun-warmed area can cause a momentary temperature drop which could cause a false event to be recorded. The warmed air rising from the ground can cause problems too.
  - Tall, sun-warmed grasses or other vegetation blowing in a breeze can be detected. Point the sensor away from dense, sun-warmed vegetation which can trap heat.
  - Even in a shaded area, keep the sensor pointed away from dense shrubs or trees that can retain the day's warmth. A warm evergreen or other dense shrub will hold the day's heat. If the air temperature drops at night - and the still warm shrub moves in the wind, this movement could be detected.
  - If the area is known to have many small birds / mammals, you will surely get many empty pictures, as these active, fast animals will often leave the frame before a picture can be taken. Orient your sensor to your target.
  - Wind (moving air) can cause false events. The moving air might be warmer or cooler than the background. Place the sensor in an area sheltered from strong winds when you use your PIR sensor equipped cameras in a location prone to high winds.
  - Wind can also cause movement of the tree or other object you have your sensor mounted to. Make sure to secure your sensor to an object that will not sway in strong winds. Trees should be a minimum of 25 cm in diameter.
  - Make sure your equipment is fastened securely. Movement of the equipment can be interpreted as motion by the sensor.

**PIR Motion Sensors Basic Overview for Effective Use**

All TrackSnap cameras use a PixController PIR motion detection sensor. **PIR** stands for **Pryoelectric Infra-Red**, which detects warm targets in motion over ambient background temperature. A stationary target or a target not moving can not be detected. The target must also have a warmer surface temperature than the ambient background temperature in order to be detected.

The size of the target and the distance of the target from the PIR sensor will also effect if the target can be detected or not. Smaller targets such as birds and small mammals may not be detected especially if they are moving fast or are at a great distance from the PIR sensor. Larger targets such as medium size and large size mammals are easily detected within the range of the PIR detection area (see below). However, if you increase the sensitivity of the PIR sensitivity POT you can detect smaller targets, but you run the risk of a greater chance of false triggers.

**PIR Sensor Detection Area**

As ambient background temperatures rise to near 35.5°C, the difference between the target and ambient background temperature decreases for warm-blooded targets. The sensitivity of the PIR sensor declines in this instance. However, as ambient background temperature decrease the opposite is true and the sensor PIR becomes more sensitive. Under these conditions you can adjust the PIR sensitivity POT to accommodate your detection range needs. The graphics below show an example of the PIR detection area at around 20°C. The PixController PIR sensor is unique in that the target does not need to be moving from right to left, or left to right. The sensor can detect the target in any vector of travel (say up and down target movement), which is very important if you plan to mount your camera in an elevated position for security reasons.

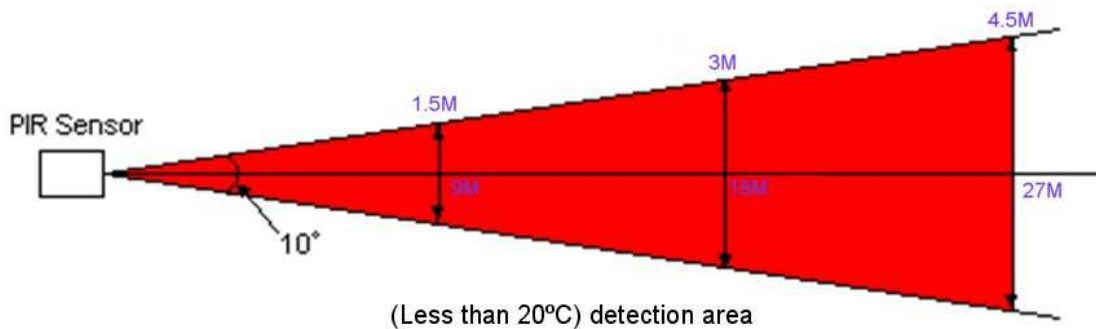

The red area is the PIR detection area in the above graphic.

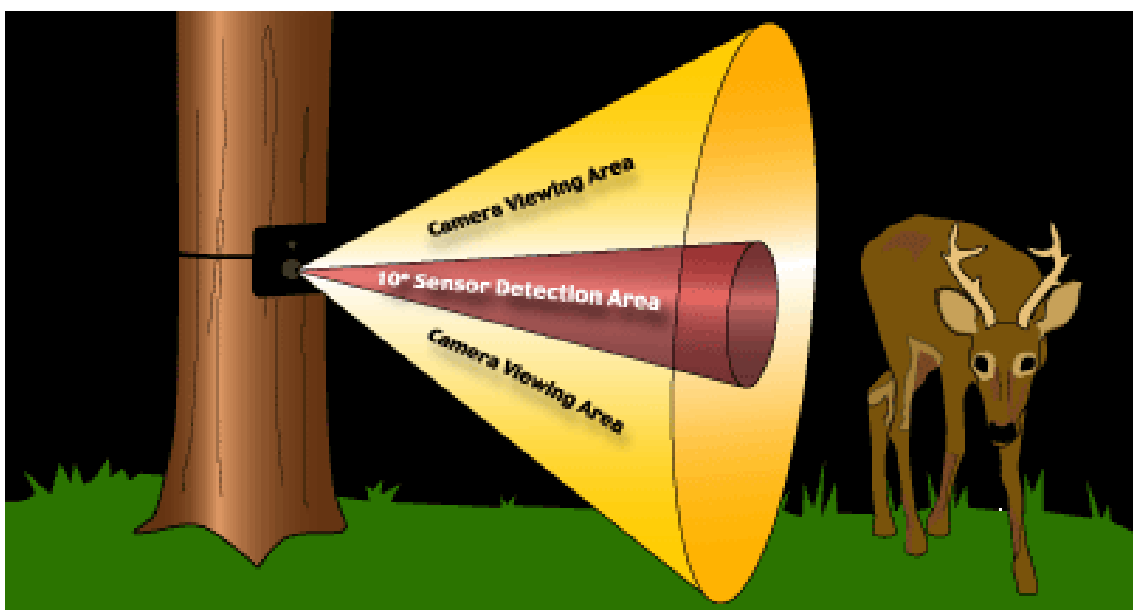

**Auto Walk-Test mode on power up**

When turning power on to your TrackSnap both the red and green LED will light up. They will both stay on for 30 seconds. This time will allow the PIR circuit to warm up. After this time expires the green LED will turn off and the red LED will blink 5 times letting you know that the board is entering a 1 minute **automatic walk-test phase**. At this point you can move around the camera setup and check out the PIR area. Both the green and red LED's will light when motion is detected. After the 1 minute automatic walk-test phase expires the red LED will blink 5 times letting you know the camera system will now become active.

**Adjusting the PIR Sensitivity POT**

**PIR Sensitivity POT**

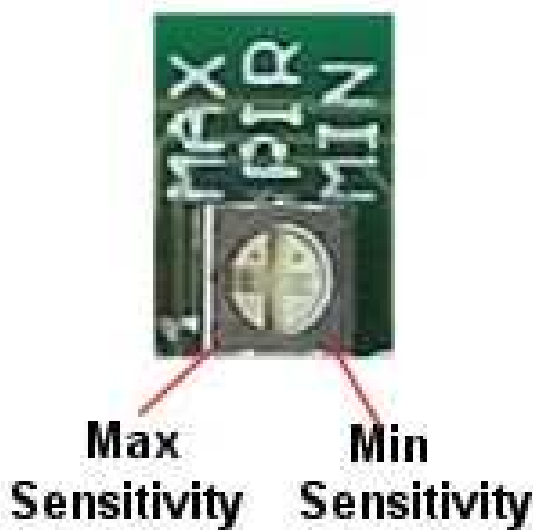

To adjust the PixController PIR detection range simply turn the single turn POT shown to the left to your desired range. The default setting is in the middle, as shown. The two “dots” on the Philips head screw show the actual location.

The default setting is desirable for almost all weather conditions. In very hot summer months, or setups over fields with no shading cover you should reduce the PIR sensitivity.

**Note:** *Turning the sensitivity to the minimum setting will turn the PIR detection off.*

**Adjusting the Day/Night Cal. POT**

**Day/Night Sensor Cal. POT**

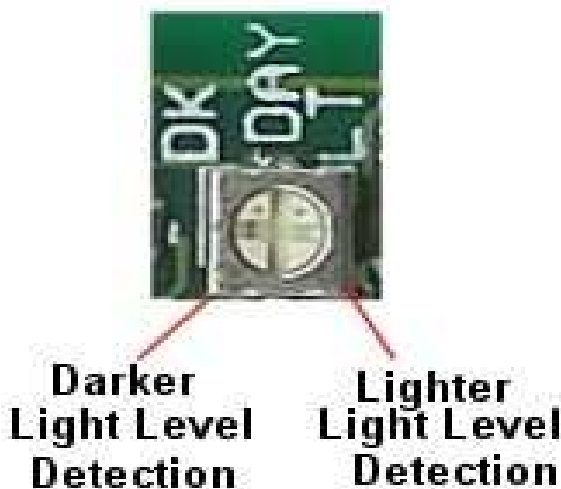

When adjusting the Day/Night Sensor POT you must first set the DIP switches 3 & 4 “Up” when the board is powered down, and then turn the board on. The “Red Control LED” will light up when the detection level detects darkness. You may want to adjust this in the darkest setting you want to run your system at when adjusting this POT. When finished you will need to return DIP switches 3 & 4 back to their original setting.

**DIP Switch Settings**

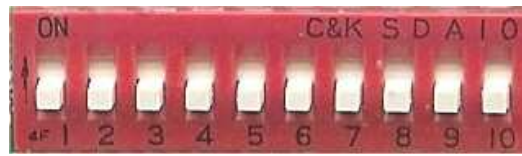

*PixController 10-Position DIP Switch*

**Introduction**

The 10-Position DIP switch on the PixController board is used to setup how the board controls the attached cameras, functions in day only, night only, 24 hour mode, and many more features. Listed below are instructions on how to setup the DIP switch feature on the LE board.

**Default Setting**

The default settings for your camera are marked in Yellow

All switches Down (Off) except SW6 and SW10 Up (ON) and a summary is listed:

- 10 Sec PIR Delay
- 24 hour mode of operation
- Sony P32/P41 Camera
- Continuous movement movie setting
- Green PIR LED ON

**PIR Delay Setting**

Switches 1 and 2 control the delay between PIR events. This setting is used so you can limit or not limit the number of photos taken when a motion event triggers your board. For example when you set your system up on a track you will want the 10 second delay setting so you can capture as many photos as possible, but when setup over a feeder you want to use the 10 minute PIR delay so you limit the number of photos of one animal.

PIR Delay	Switch 1	Switch 2
10 Seconds	Down/Off	Down/Off
2 Minutes	Down/Off	Up/On
5 Minutes	Up/On	Down/Off
10 Minutes	Up/On	Up/On

**Mode Setting**

Switches 2 and 3 control the mode of operation of your PixController board. Here you can setup if the board is to function 24 hours a day, night only, or day only. The last setting sets up the day/night sensor light detection level. This is useful for setting up your PixController board to detect light/darkness levels.

Mode	Switch 3	Switch 4
24 Hour Operation	Down/Off	Down/Off
Night Only	Down/Off	Up/On
Day Only	Up/On	Down/Off
Day/Night Sensor Calibration.	Up/On	Up/On

### Camera Attached Setting

Switches 5, 6, and 7 setups which camera is attached to your PixController board. Note: Even though there are 2 different PIC controller chips available for the PixController LE (Original and LE II) your camera is using the Original chip. Both are listed below are the settings for the corresponding controller chip for reference on which other cameras can be used.

Camera (Original LE)	Switch 5	Switch 6	Switch 7
Sony/Canon LANC Camcorder - <i>Plug-n-Play</i>	Down/Off	Down/Off	Down/Off
ACC-Terminal - <i>Plug-n-Play</i>	Down/Off	Down/Off	Up/On
<b>Sony DSC-PXX (Sony P32/P41)</b>	<b>Down/Off</b>	<b>Up/On</b>	<b>Down/Off</b>
Minolta X20, Sony DSC-UXX (Sony U30)	Down/Off	Up/On	Up/On
RSS (D380/D370/35mm always on mode)	Up/On	Down/Off	Down/Off
RSP (on/off digital camera mode using external supply)	Up/On	Down/Off	Up/On
RSP3i (on/off mode, internal supply, D370/D380)	Up/On	Up/On	Down/Off
RSP4i (on/off mode, internal supply, D390/D395)	Up/On	Up/On	Up/On
Camera (LE II)	Switch 5	Switch 6	Switch 7
Sony/Canon LANC Camcorder in VTR mode - <i>Plug-n-Play</i>	Down/Off	Down/Off	Down/Off
Sony/Canon LANC Camcorder in Photo mode - <i>Plug-n-Play</i>	Down/Off	Down/Off	Up/On
Sony DSC-S40/DSC-S600	Down/Off	Up/On	Down/Off
Samsung A402	Down/Off	Up/On	Up/On
Olympus D-425	Up/On	Down/Off	Down/Off
Digital Concepts 2.1 (DC 2.1)	Up/On	Down/Off	Up/On
DVR - Wireless (DVR control mode for wireless video cameras)	Up/On	Up/On	Down/Off
Olympus D-360L "Hardwire"	Up/On	Up/On	Up/On

### Picture Mode Setting

Switch 8 controls the operation of the attached camera. You can either setup your camera in digital still mode, or movie/double photo mode. If you want to take digital movies with your digital camera you must have your digital camera setup in movie mode. If your camera setting is in RSP mode, however, you can setup Charge Mode On/Off, which is used to keep your camera settings. Note, when the board is setup in LANC mode these setting will not apply. You must follow the "LANC Video Delay Setting" listed below.

Picture Mode	Switch 8
Still / RSP Charge Mode off	Down/Off
Movie or Double Photo / RSP Charge Mode On	Up/On

### Camera Mode Setting

Switch 9 controls fast/slow camera operation. This is useful for setting up fast/slow refresh mode in RSS camera mode, or setting up a delay for larger memory cards. If switch 8 is setup in "Movie Mode" then this switch setting is for 10 or 15 second movie clip, or the time delay between double photo modes. If you want to take digital movies with your digital camera you must have your digital camera setup in movie mode. Note, when the board is setup in LANC mode these setting will not apply. You must follow the "LANC Video Delay Setting" listed below.

Camera Mode	Switch 9
Fast / 10 second digital movie clip	Down/Off
Slow / 15 second digital movie clip	Up/On

**LANC Video Delay Setting**

Switches 8 and 9 sets up the recording time for your LANC camcorder.

Recording Time	Switch 8	Switch 9
30 Seconds - Continuous recording as long as motion is present.	Down/Off	Down/Off
1 Minute	Down/Off	Up/On
2.5 Minutes	Up/On	Down/Off
5 Minutes	Up/On	Up/On

**Green PIR LED Setting**

Switches 10 controls the green PIR LED.

PIR Delay	Switch 10
LED Off	Down/Off
LED On	Up/On

**Motion Sensor Control board Specifications****Board Operating Conditions**

Operating Voltage: 5V - 14V DC

Recommended Operating Temperatures: 48.8°C to -12.2 °C

Battery Life: ~9 months on An Alkaline 9V. Actual times depend on operating temperature.

**Board Dimension**

31.75mm X 81.28mm

**User Feedback**

Red (Super Bright) control LED: Displays board functions

Green PIR LED: Displays PIR triggers

**Sensors**

PIR Sensor: Pyroelectric Infrared motion sensor. Detection range out to 24.4 Metres depending on temperature.

CDS Photo Sensor: Detects light/dark for day/night operation.

**Interface Ports**

Sony/Canon LANC Port

Sony ACC Terminal Port

Hardwire Camera Control - Shutter, Refresh, Power On/Off

DC Power Port

External Light Port

**User Interfaces**

10 Position DIP Switch: Adjust board operating settings

Single Turn PIR Sensitivity POT: Adjust PIR Range/Sensitivity

Single Turn Day/Night Sensor Calibration POT: Adjust the light detection level of your Day/Night Sensor.

## Inside Your TrackSnap Camera



## PixController Main Board Features

- **Board can be mounted vertically or horizontally.** The unique dual element PIR sensor enables the camera to be used in any orientation.
- **External light port.** This can switch up to a 4.2 amp supply for lights and IR LED arrays.
- **Dual LED's for better board diagnostics.** The unique LED's design, super bright red control LED, and green PIR LED is used on all of our motion sensing boards. The LED layout is designed to shine through the PIR lens in your case.
- **Controls LANC Video Camcorder, Digital Cameras, and 35mm Cameras all on one board!**
- **Fast re-trigger PIR!** *Can be re-triggered within 1 second* With this you get features like continuous filming as long as motion is present for LANC camcorder setups.
- **Fast and Slow camera start-up modes.** *Allows you to use any kind of memory card in your camera.*
- **Day, Night, or 24 hour operation setting.**
- **Auto walk test mode on power up.** The walk test mode will blink every time you walk into the PIR detection area. It gives instant feedback.
- **Low battery level detection** - the green PIR LED will blink when a low battery is detected.
- **10-Position DIP switch** so you can easily configure board settings.
- **Tiny board size.** Fit a Sony DSC-P41 into a Pelican 1060 case with room to spare.
- **PIR sensitivity POT** to adjust the PIR detection range.
- **Day/Night sensor POT** to adjust the light detection level. There is a DIP switch setting in which you can calibrate this setting. The red control LED will be on when it detects darkness and gives you continuous feedback.
- **Auto PIR shut-down on low battery detection.** *Minimises false photos when battery becomes low!*
- **Reverse polarity circuit.** This will protect your board if you install a battery backwards. There is an on-board fuse to protect your investment!
- **Professionally built, assembled, and tested.**
- **TTL Slave Flash trigger output.** – To be used in conjunction with an external Slave Flash board. This allows the use of very inexpensive Digital CMOS board cameras.

**PixController LE (Rev. 2) Control Board Front**

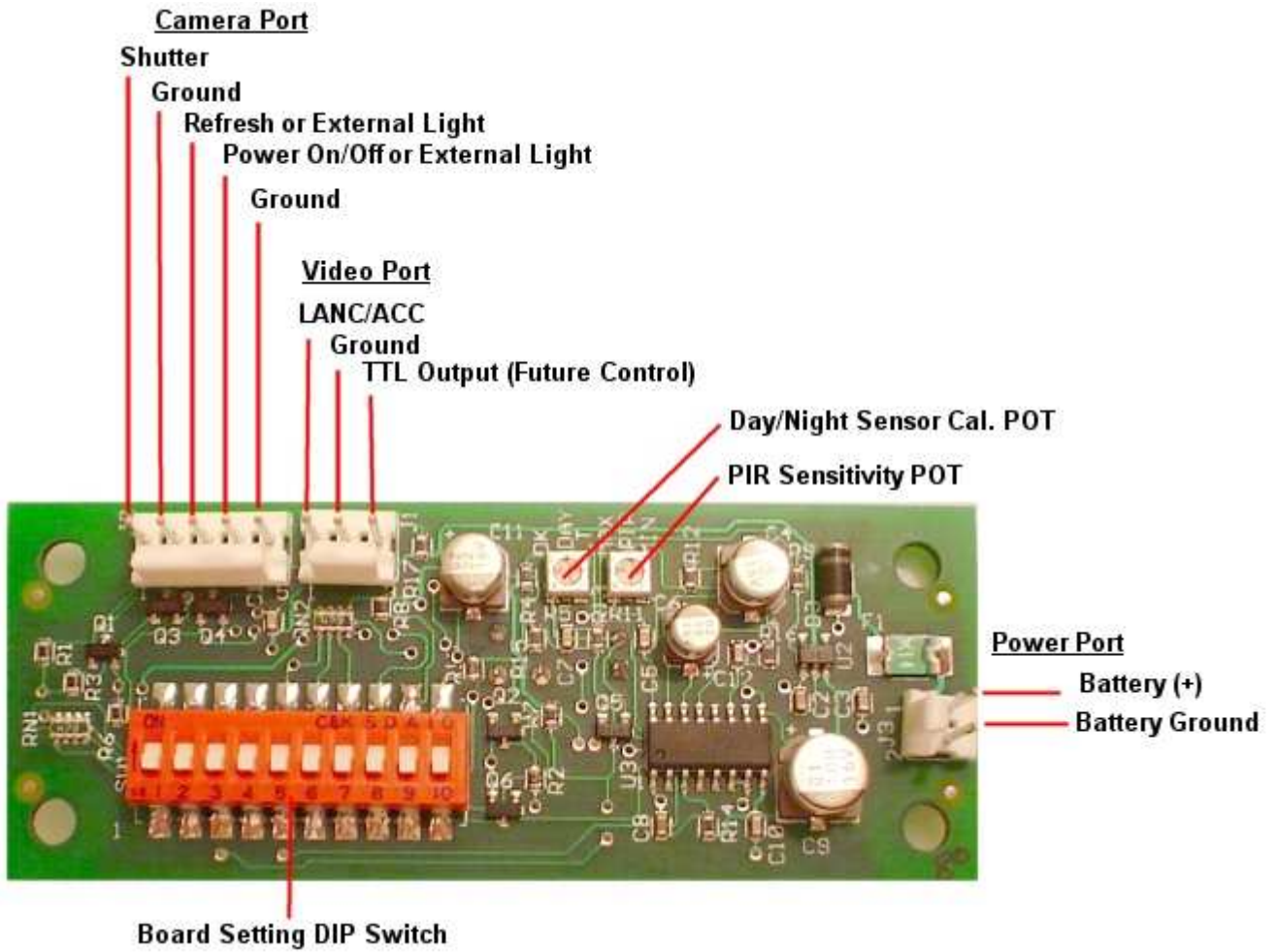

**PixController LE Control Board Back**

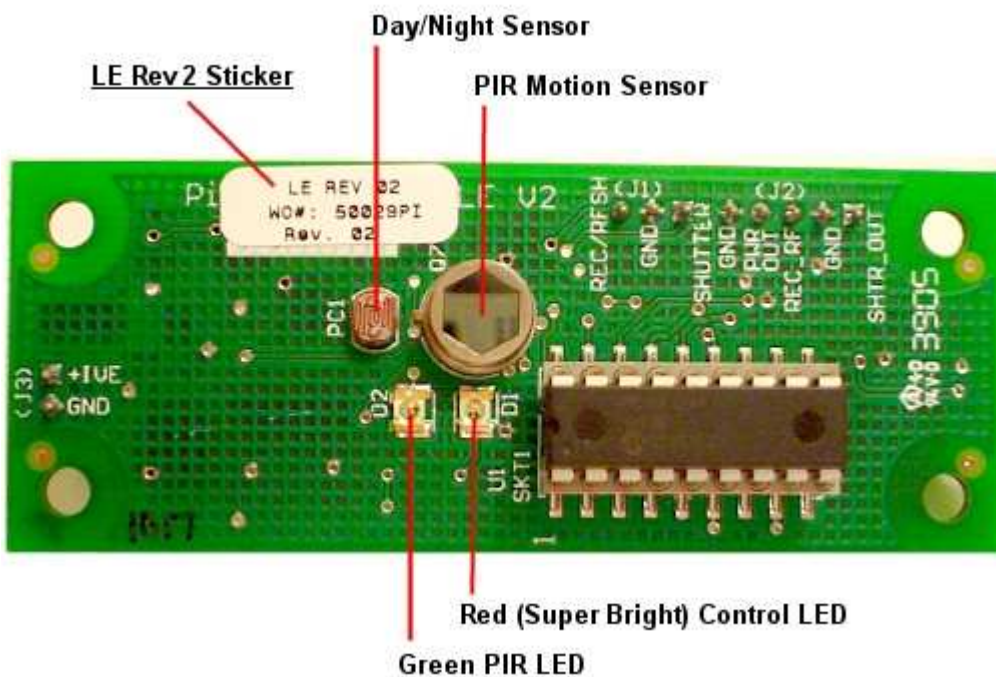

**Mounting the PIR Lens**

The PIR lens is mounted in the Pelican 1060 case with your board. The lens is centred over the PIR Sensor and is 16.5 mm from the top. We mount the lens with the “ridges” facing towards the PIR sensor. Do not scratch the lens on either side. Also, **do not mount any glass, tape or plastic film over top of the PIR lens**. These will not let infrared heat to pass through to trigger your PIR sensor. The PIR lens is glued to the inside of the case (lens ridges pointed in, smooth side out), with a waterproof adhesive.

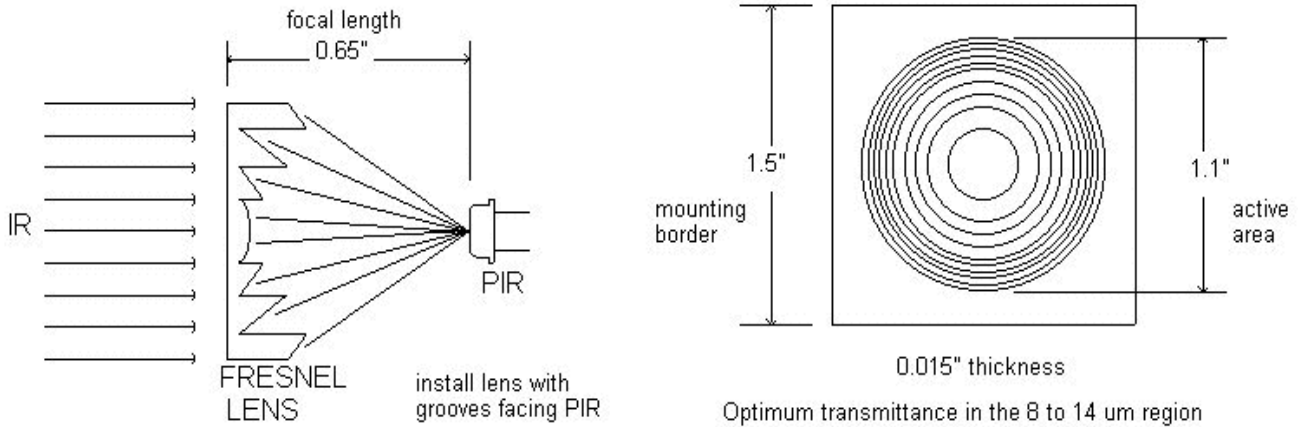

**Fast Re-Trigger PIR detection electronics**

The PixController PIR detection electronics is unique in that it recovers very fast after each PIR detection trigger and will be able to detect the next detection trigger almost immediately. This makes Walk-Test mode on this system a very usable feature. The key is that the PixController PIR circuit used advanced digital detection electronics. The PIR detection electronics recovery time is only 1/2 second!

**LE Board Mounting - PIR Sensor Considerations**

The PIR sensor will allow the TrackSnap Camera to be used horizontally or vertically without needing the PIR sensor to be rotated. The PIR sensor circuit is the most rugged and reliable on the market today. Triggering occurs when a change in infrared levels is detected, as when a warm object moves in or out of view of one of the sensor’s “eyes.” The PIR sensor design is quite resistant to false triggering. Also, the camera can be mounted in elevated positions such as from high in a tree.

**Pelican 1060 Micro Case**

The Black case used in the TrackSnap Camera is a standard Pelican 1060 Micro Case modified for remote camera applications. It is part of the Pelican Micro Case Series. Whilst the Micro Case will protect your camera and electronics, as they are water-resistant, crushproof and have an automatic pressure purge valve, **THE CASE WILL NOT PROTECT THE CAMERA FROM SEVERE IMPACT**. The camera itself is not shockproof and the referred impact will be likely to damage the camera. Caution should be taken to avoid impacts such as this.

The case includes a lanyard for easy attachment and has two external U bolts for mounting onto trees and posts.

Case TEMPERATURE RATING			
<b>MINIMUM</b>	-10° F (-23° C)	<b>MAXIMUM</b>	+200° F (+93° C) - <b>NOT CASE CONTENTS</b>
DIMENSIONS			
<b>INSIDE</b>	8-7/16" x 4-7/16" x 2-1/4" (21.43 cm x 11.27 cm x 5.71 cm)	<b>OUTSIDE</b>	9-3/8" x 5-9/16" x 2-5/8" (23.81 cm x 14.13 cm x 6.67 cm)

**Sony DSC-P41 Camera Settings and SPECIFICATIONS:****Default TrackSnap Camera Setup - for fastest shutter times:**

- **Camera Mode Selector** – Mid position – Still Images
- **Camera must be powered off** for TrackSnap to work correctly
- Red eye reduction turned **Off**
- AF illuminator turned **Off**
- Power save turned **Off**
- Beep turned **Off**
- Focus Is set to **infinity “∞”**
- ISO is set to **400**
- Leave the camera - **On program setting**

## LENS

- F:2.8
- f:5.0mm
- f (35mm Conversion):33mm
- Fixed Zoom:
- 3 x Precision Digital Zoom :
- Smart Zoom:3 Mega:1.1x, 1.0 Mega:1.8x, VGA:3.6x
- Minimum Focal Depth:100mm with Auto Macro
- Automatic Shutter Speed: Auto (1/8 - 1/1000), Program Auto (1 - 1/1000)

## CCD

- CCD:1/2.7” 4,231,000pixels
- Scan System: Interlace

## IMAGE SIZES

- 4.0MP:2304 x 1728
- 3.1MP: :2048 x 1536
- 1.0MP: :1280 x 960
- VGA: :640 x480
- 3:2 Aspect Resolution:2304 x 1536

## GENERAL

- Digital Playback Zoom:5x Precision
- Compression: PEG/MPEG
- LCD:1.5” 67,000 pixel
- Optical View Finder: Yes
- Built in Microphone: Electret Condenser Microphone. Speaker: Dynamic
- Recording Modes: Normal, Burst, Multi Burst, MPEG Movie VX and VX Fine
- Exposure Control: +/- 2.0EV
- Maximum Images (approx): Up to 243 standard VGA images with 16MB Memory Stick. (14821 on 1G Memory Stick Pro)
- Approximate Battery Life on Supplied batteries :80 shots (Using Optional Sony NiMH AA Batteries: 400 shots/200mins)
- Weight:134g (without accessories)
- Dimensions (WxHxD):101.2x53.7x35.6mm

**Troubleshooting**

Symptom	Cause	Solution
TrackSnap will not power up.	Check switch on battery holder is in the on position. Check 9V Alkaline battery	Turn on switch Replace battery
When I turn power on to my TrackSnap the PixController board green PIR LED is blinking, and nothing else happens.	This is the indication that your batteries are low. The <b>Pix</b> Controller board has a built-in battery level indicator and when the power supply is too low the PIR will shut down, and blink the green LED. The camera may take false photos when batteries get low.	Change the 9V Alkaline battery
When I use the PixController DIP Switch setting for "Movie Mode" I still get still photos. What am I doing wrong?	Be sure to setup your Sony Camera into Movie taking mode.	Refer to your Camera manual for setting this mode.
Why is there sometimes nothing in my photo on my outdoor setups?	Sometimes birds can fly past your camera setup and trigger the camera. A bird flying past can be too fast for this camera to catch. You may also have a "false photo". Sometimes on warmer days objects that heat up to warm blooded animal temperatures and move can fool the PIR into thinking an animal walked passed.	Try turning down the "PIR Sensitivity POT" to be less sensitive on warmer days
Camera is not powering up	Camera batteries are not installed properly Camera batteries are too low for the camera.	Check and / or replace batteries with either extra Alkaline or charged NiMh rechargeable batteries
Picture quality is poor	Check Camera location and setup.	See setup tips on pages 2 and 11 of this manual and refer to camera manual for more detailed camera settings
Object in picture is out of focus	The TrackSnap default setup is on page 11 and set to infinity. Check the focus setting.	Set focus to correct setting.
The TrackSnap does not take photos at night or only take photos at night.	DIP Switches 3 & 4 are set incorrectly. Night sensor is obstructed.	See page 5 for correct Day / night setting.